

- Ultra-slim, 5 mm wide
- Sensitive DC coil, 170 mW
- 6/8 mm clearance/creepage distance
- 6 kV (1.2/50 μ s) between coil and contacts

34.51

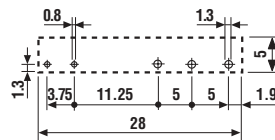

- 5 mm wide
- P.C.B./for use with 93 series sockets

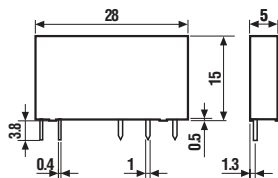
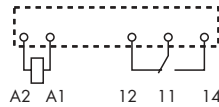

Copper side view

* For 400 V applications, where requirements for pollution degree 2 are met.

Contact specifications		
Contact configuration		1 CO (SPDT)
Rated current/Maximum peak current	A	6/10
Rated voltage/Maximum switching voltage V AC		250/400*
Rated load in AC1	VA	1,500
Rated load in AC15 (230 V AC)	VA	300
Single phase motor rating (230 V AC)	kW	0.185
Breaking capacity in DC1: 30/110/220 V	A	6/0.2/0.12
Minimum switching load	mW (V/mA)	500 (12/10)
Standard contact material		AgNi
Coil specifications		
Nominal voltage (U _N)	V AC (50/60 Hz)	—
	V DC	5 - 12 - 24 - 48 - 60
Rated power AC/DC	VA (50 Hz)/W	—/0.17
Operating range	AC	—
	DC	(0.7... 1.5)U _N
Holding voltage	AC/DC	—/0.4 U _N
Must drop-out voltage	AC/DC	—/0.05 U _N
Technical data		
Mechanical life AC/DC	cycles	—/10 · 10 ⁶
Electrical life at rated load AC1	cycles	60 · 10 ³
Operate/release time	ms	5/3
Insulation according to EN 61810-1 ed. 2		4 kV/3
Insulation between coil and contacts (1.2/50 μ s)	kV	6
Dielectric strength between open contacts V AC		1,000
Ambient temperature range	°C	-40...+85
Environmental protection		RT II
Approvals (according to type):		
		GOST

- Ultra-slim, 5 mm wide
- High switching speed and endurance
- Silent switching

34

34.81-9024

34.81-7048

34.81-8240



- Switching current 2 A -
24 V DC
- P.C.B. mounting

- Switching current 0.1 A -
48 V DC
- P.C.B. mounting

- Switching current 2 A -
240 V AC
- P.C.B. mounting

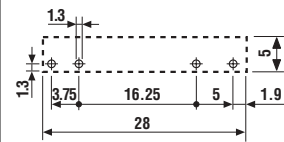
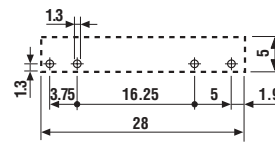
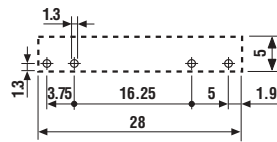
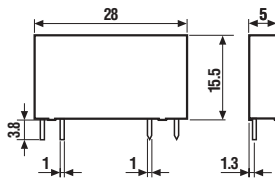
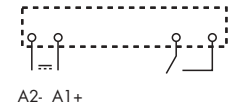
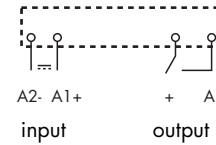
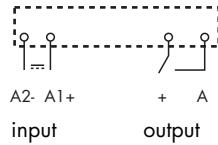

Copper side view

Copper side view

Copper side view

Output circuit							
Contact configuration		1 NO (SPST-NO)		1 NO (SPST-NO)		1 NO (SPST-NO)	
Rated current/Maximum peak current (10 ms)	A	2/20		0.1/0.5		2/40	
Rated voltage/Maximum blocking voltage	V	24/33 DC		48/60 DC		240/275 AC	
Switching voltage range	V	(1.5...24)DC		(1.5...48)DC		(12...240)AC	
Minimum switching current	mA	1		0.05		22	
Max "OFF-state" leakage current	mA	0.001		0.001		1.5	
Max "ON-state" voltage drop	V	0.12		1		1.6	
Input circuit							
Nominal voltage	V DC	24	60	24	60	24	60
Operating range	V DC	16...30	35...72	16...30	35...72	16...30	35...72
Control current	mA	7	3	7	3	7	3
Release voltage	V DC	10	20	10	20	10	20
Impedance	Ω	3,200	21,300	3,200	21,300	3,200	21,300
Technical data							
Operate/release time	ms	0.1/0.3*		0.02/0.1*		12/12*	
Dielectric strength between input/output	V	2,500		2,500		2,500	
Ambient temperature range	°C	-20...+60		-20...+60		-20...+60	
Environmental protection		RT III		RT III		RT III	
Approvals (according to type):						—	

* Operate/release time: if the relays are used with 35 mm rail sockets types 93.01 and 93.51, refer to the technical data of 38 Series, page 98.

ORDERING INFORMATION

ELECTROMECHANICAL RELAY

Example: a 34 series slim electromechanical relay, 1 CO (SPDT) 6 A, with 24 V sensitive DC coil.

3 4 . 5 | **1 . 7 .** | **0 2 4 .** | **A** | **B** | **C** | **D**
0 0 1 0

Series ————

Type ————
5 = Electromechanical type

No. of poles ————
1 = 1 pole, 6 A

Coil version ————
7 = Sensitive DC

Coil voltage ————
see coil specifications

A: Contact material
0 = Standard AgNi
4 = AgSnO₂
5 = AgNi + Au

B: Contact circuit
0 = CO (SPDT)
3 = NO (SPST)

C: Options
1 = None

D: Special versions
0 = Flux proof (RT II)
9 = Flat version

Only combinations in the same row are possible

Preferred versions

	coil version	A	B	C	D
34.51	sens. DC	0	0	1	0

All versions

	coil version	A	B	C	D
34.51	sens. DC	0 - 4 - 5	0 - 3	1	0
34.51	sens. DC	0 - 4 - 5	0	1	9

SOLID STATE RELAY

Example: a 34 series SSR relay, 2 A, with 24 V DC supply.

3 4 . 8 | **1 . 7 .** | **0 2 4 .** | **9 0 2 4**

Series ————

Type ————
8 = SSR type

Output ————
1 = 1 NO (SPST-NO)

Input circuit ————
see input specifications

Output circuit
9024 = 2 A - 24 V DC
7048 = 0.1 A - 48 V DC
8240 = 2 A - 240 V AC

Note: All technical data relates to using the relay directly on PCB or PCB socket type 93.11. If the relay is use with 35 mm rail socket types 93.01 or 93.51, refer to the technical data of 38 Series, page 98.

POSSIBLE OPTIONS



Option = 34.51.7xxx.x019

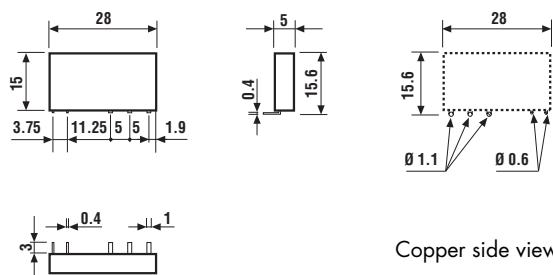

ELECTROMECHANICAL RELAY

34 TECHNICAL DATA

INSULATION

Insulation according to EN 61810-1 ed. 2	insulation rated voltage	V	250
	rated impulse withstand voltage	kV	4
	pollution degree		3
	overvoltage category		III

CONDUCTED DISTURBANCE IMMUNITY

Burst (5...50)ns, 5 kHz, on A1 - A2	EN 61000-4-4	level 4 (4 kV)
Surge (1.2/50 μs) on A1 - A2 (differential mode)	EN 61000-4-5	level 3 (2 kV)

OTHER DATA

Bounce time: NO/NC	ms	1/6	
Vibration resistance (10...55)Hz, max. ± 1 mm: NO/NC	g/g	10/5	
Power lost to the environment	without contact current	W	0.2
	with rated current	W	0.5
Recommended distance between relays mounted on P.C.B.s	mm	≥ 5	

CONTACT SPECIFICATIONS

F 34

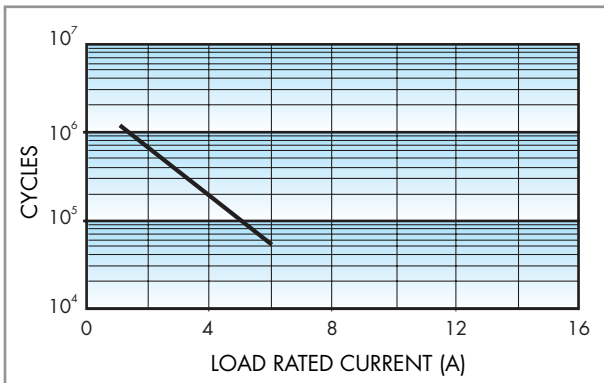

Electrical life vs AC1 load.

H 34

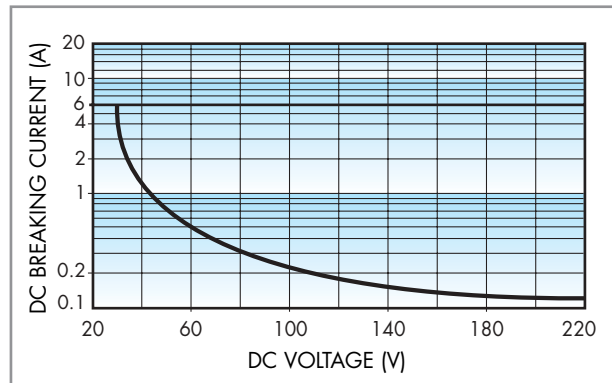

Breaking capacity in DC1 load.

- When switching a resistive load (DC1) having voltage and current values under the curve the expected electrical life is $\geq 60 \cdot 10^3$ cycles.
- In case of DC13 loads the connection of a diode in parallel with the load will permit the same electrical life as for a DC1 load.

Note: the release time of load will be increase.

COIL SPECIFICATIONS

DC VERSION DATA

Nominal voltage U_N V	Coil code	Operating range		Resistance R Ω	Rated coil consumption I at U_N mA
		U_{min} V	U_{max} V		
5	7.005	3.5	7.5	130	38.4
12	7.012	8.4	18	840	14.2
24	7.024	16.8	36	3,350	7.1
48	7.048	33.6	72	12,300	3.9
60	7.060	42	90	19,700	3

R 34 DC

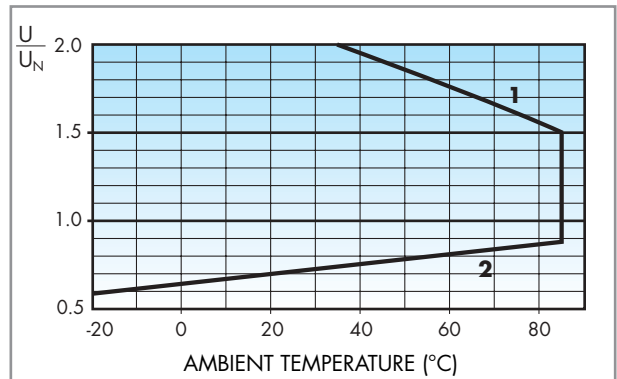

Operating range vs ambient temperature.

1 - Max coil voltage permitted.

2 - Min pick-up voltage with coil at ambient temperature.

SOLID STATE RELAY
TECHNICAL DATA
OTHER DATA

Power lost to the environment	without output current	W	0.17
	with rated current	W	0.4

INPUT SPECIFICATION
DC VERSION DATA

Nominal voltage U_N	Input code	Operating range		Release voltage	Control current I at U_N
		U_{min}	U_{max}		
V		V	V	V	mA
24	7.024	16	30	10	7.5
60	7.060	35	72	20	3

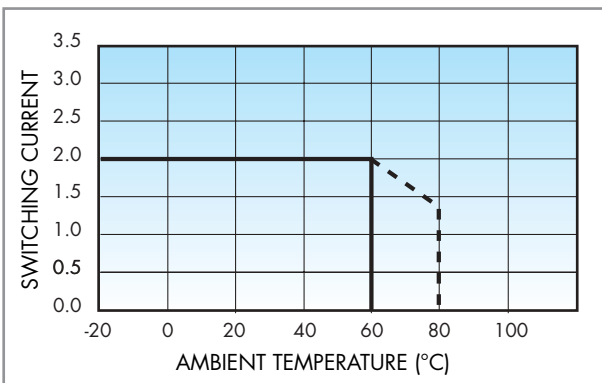
OUTPUT SPECIFICATION
L 34/2A

Type 34.81 (2 A - 24 V DC and 2 A - 240 V AC)
Switching current vs ambient temperature.

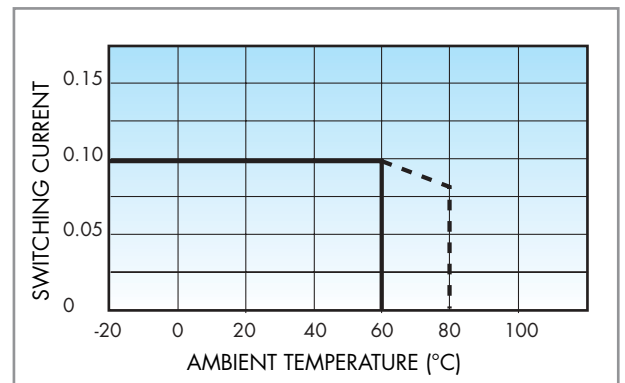
L 34/0.1A

Type 34.81 (100 mA - 48 V DC)
Switching current vs ambient temperature.

34



93.01

Approvals
(according to type):

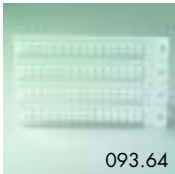
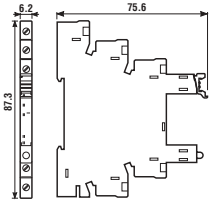

093.64

Relay type	34.51, 34.81	
Screw terminal socket: 35 mm (EN 50022) mounting		
Supply voltage	Relay type	Socket type
12 V AC/DC	34.51.7.012.xx10	93.01.0.024
24 V AC/DC	34.51.7.024.xx10	93.01.0.024
48 V AC/DC	34.51.7.048.xx10	93.01.0.060
60 V AC/DC	34.51.7.060.xx10	93.01.0.060
(110...125)V AC/DC	34.51.7.060.xx10 or 34.81.7.060.xxxx	93.01.0.125
(220...240)V AC/DC	34.51.7.060.xx10 or 34.81.7.060.xxxx	93.01.0.240
(110...125)V AC/DC*	34.51.7.060.xx10 or 34.81.7.060.xxxx	93.01.3.125*
(220...240)V AC*	34.51.7.060.xx10 or 34.81.7.060.xxxx	93.01.3.240*
6 V DC	34.51.7.005.xx10	93.01.7.024
12 V DC	34.51.7.012.xx10	93.01.7.024
24 V DC	34.51.7.024.xx10 or 34.81.7.024.xxxx	93.01.7.024
48 V DC	34.51.7.048.xx10	93.01.7.060
60 V DC	34.51.7.060.xx10 or 34.81.7.060.xxxx	93.01.7.060
Sheet of marker tags (64 tags), 6x10 mm		093.64

* Leakage current suppression.

- Rated values: 6A - 250 V
- Insulation: ≥ 6 kV (1.2/50 μ s) *between coil and contacts*
- Protection category: IP 20
- Ambient temperature: (-40...+70) $^{\circ}$ C ($U_N \leq 60$ V), (-40...+55) $^{\circ}$ C ($U_N \geq 60$ V)
- \ominus Screw torque: 0.5 Nm
- Wire strip length: 10 mm
- Max wire size:

	solid wire	stranded wire
mm ²	1x2.5 / 2x1.5	1x2.5 / 2x1.5
AWG	1x14 / 2x16	1x14 / 2x16



93.51

Approvals
(according to type):

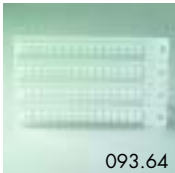
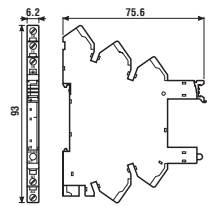

093.64

Relay type	34.51, 34.81	
Screwless terminal socket: 35 mm (EN 50022) mounting		
Supply voltage	Relay type	Socket type
12 V AC/DC	34.51.7.012.xx10	93.51.0.024
24 V AC/DC	34.51.7.024.xx10	93.51.0.024
(110...125)V AC/DC	34.51.7.060.xx10 or 34.81.7.060.xxxx	93.51.0.125
(220...240)V AC/DC	34.51.7.060.xx10 or 34.81.7.060.xxxx	93.51.0.240
(110...125)V AC/DC*	34.51.7.060.xx10 or 34.81.7.060.xxxx	93.51.3.125*
(220...240)V AC*	34.51.7.060.xx10 or 34.81.7.060.xxxx	93.51.3.240*
12 V DC	34.51.7.012.xx10	93.51.7.024
24 V DC	34.51.7.024.xx10 or 34.81.7.024.xxxx	93.51.7.024
60 V DC	34.51.7.060.xx10 or 34.81.7.060.xxxx	93.51.7.060
Sheet of marker tags (64 tags), 6x10 mm		093.64

* Leakage current suppression.

- Rated values: 6A - 250 V
- Insulation: ≥ 6 kV (1.2/50 μ s) *between coil and contacts*
- Protection category: IP 20
- Ambient temperature: (-40...+70) $^{\circ}$ C ($U_N \leq 60$ V), (-40...+55) $^{\circ}$ C ($U_N \geq 60$ V)
- Wire strip length: 10 mm
- Max wire size:

	solid wire	stranded wire
mm ²	1x2.5	1x2.5
AWG	1x14	1x14

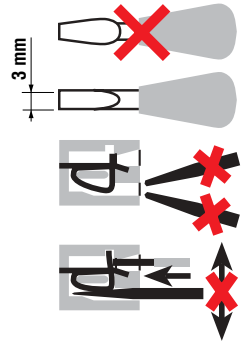



93.11

Approvals
(according to type):



Relay type	34.51/34.81
Colour	BLUE
P.C.B. sockets with retaining and release clip	93.11

- Rated values: 6 A - 250 V
- Insulation: ≥ 6 kV (1.2/50 μ s) *between coil and contacts*
- Protection category: IP 20
- Ambient temperature: (-40...+70) $^{\circ}$ C

Retaining and release clip use:

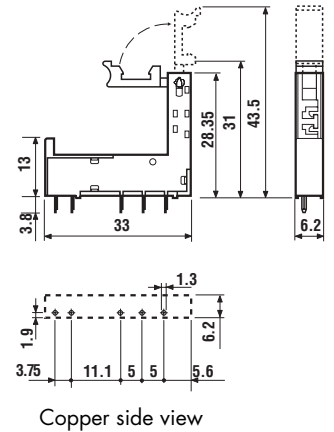
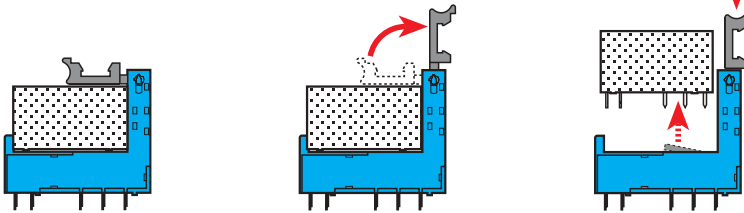

FOR 93.01 AND 93.51 SOCKETS:

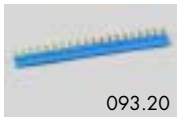

093.20

Approvals
(according to type):



20-way jumper link	093.20
---------------------------	--------

- Rated values: 36 A - 250 V

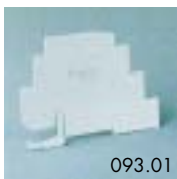
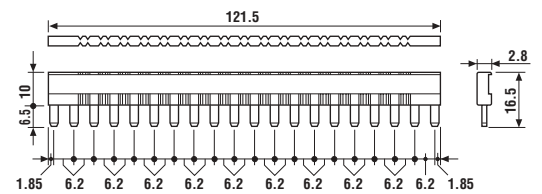

093.01

Plastic separator	093.01
--------------------------	--------

- Thickness 2mm, required at the start and the end of a group of interfaces.
Can be used for visual separation group, must be used for:
- protective separation of different voltages of neighbouring PLC interfaces according to VDE 0106-101
 - protection of cut jumper links

